



GM420

Loop monitor

to monitor the PE conductor in AC systems

Software version: D268 V1.0x





Bender GmbH & Co. KG

PO Box 1161 • 35301 Grünberg • Germany
Londorfer Str. 65 • 35305 Grünberg • Germany
Tel.: +49 6401 807-0 • Fax: +49 6401 807-259
E-Mail: info@bender.de • www.bender.de

© Bender GmbH & Co. KG

All rights reserved.
Reprinting only with permission of the publisher.
Subject to change!

Photos: Bender archives

Table of Contents

1. Important information	7
1.1 How to use this manual	7
1.2 Technical support: service and support	8
1.2.1 First level support	8
1.2.2 Repair service	8
1.2.3 Field service	9
1.3 Training courses	10
1.4 Delivery conditions	10
1.5 Inspection, transport and storage	10
1.6 Warranty and liability	11
1.7 Disposal	12
2. Safety instructions	13
2.1 General safety instructions	13
2.2 Work activities on electrical installations	13
2.3 Intended use	14
3. Function	15
3.1 Device features	15
3.2 Function	15
3.2.1 Preset function	16
3.2.2 Protected measuring circuit	17
3.2.3 Automatic self test	18
3.2.4 Manual self test	18
3.2.5 Functional faults	18
3.2.6 Fault memory	18
3.2.7 Assigning alarms to the alarm relays K1/K2	18
3.2.8 Time delays t, ton and toff	18
3.2.9 Password protection (on, OFF)	19
3.2.10 Factory setting FAC	19

3.2.11 Erasable history memory	19
4. Installation and connection	21
5. Commissioning	23
5.1 Preset function/ factory setting	23
5.2 Functional tests	24
5.2.1 Alarm relays	24
5.2.2 Conductor loop resistance	24
5.3 Fast commissioning of the loop monitor in AC systems	26
6. Operation and setting	27
6.1 Display elements in use	27
6.2 Function of the operating elements	28
6.3 Menu structure	29
6.4 Display in standard mode	30
6.5 Display in menu mode	31
6.5.1 Parameter query and setting: Overview	31
6.5.2 Setting the response values for loop resistance and the associated hysteresis	33
6.5.3 Setting the response values for extraneous voltage and hysteresis	34
6.5.4 Setting the fault memory and operating mode of the alarm relays	35
6.5.5 Assigning alarm categories to the alarm relays	35
6.5.6 Setting time delays	38
6.5.7 Factory setting and password protection	39
6.5.8 Restoring factory setting	40
6.5.9 Manual activation of the preset function	41
6.5.10 Device information query	41
6.5.11 History memory query	41
7. Technical data GM420...	43
7.1 Tabular data	43

7.2	Standards, approvals and certifications	47
7.3	Ordering information	47
7.4	Document revision history	48

1. Important information

1.1 How to use this manual



*This manual is intended for **qualified personnel** working in electrical engineering and electronics!*

Always keep this manual within easy reach for future reference.

To make it easier for you to understand and revisit certain sections in this manual, we have used symbols to identify important instructions and information. The meaning of these symbols is explained below:



DANGER

*This signal word indicates that there is a **high risk of danger** that will result in **electrocution** or **serious injury** if not avoided.*



WARNING

*This signal word indicates a **medium risk of danger** that can lead to **death** or **serious injury** if not avoided.*



CAUTION

*This signal word indicates a **medium risk of danger** that can lead to **death** or **serious injury** if not avoided.*



*This symbol denotes information intended to assist the user in making **optimum use** of the product.*

1.2 Technical support: service and support

For commissioning and troubleshooting Bender offers you:

1.2.1 First level support

Technical support by phone or e-mail for all Bender products

- Questions concerning specific customer applications
- Commissioning
- Troubleshooting

Telephone: +49 6401 807-760*
Fax: +49 6401 807-259
In Germany only: 0700BenderHelp (Tel. and Fax)
E-mail: support@bender-service.de

1.2.2 Repair service

Repair, calibration, update and replacement service for Bender products

- Repairing, calibrating, testing and analysing Bender products
- Hardware and software update for Bender devices
- Delivery of replacement devices in the event of faulty or incorrectly delivered Bender devices
- Extended guarantee for Bender devices, which includes an in-house repair service or replacement devices at no extra cost

Telephone: +49 6401 807-780** (technical issues)
+49 6401 807-784**, -785** (sales)
Fax: +49 6401 807-789
E-mail: repair@bender-service.de

Please send the devices for **repair** to the following address:

Bender GmbH, Repair-Service,
Londorfer Str. 65,
35305 Grünberg

1.2.3 Field service

On-site service for all Bender products

- Commissioning, configuring, maintenance, troubleshooting of Bender products
- Analysis of the electrical installation in the building (power quality test, EMC test, thermography)
- Training courses for customers

Telephone: +49 6401 807-752**, -762 ** (technical issues)
+49 6401 807-753** (sales)

Fax: +49 6401 807-759

E-mail: fieldservice@bender-service.de

Internet: www.bender.de

*Available from 7.00 a.m. to 8.00 p.m. 365 days a year (CET/UTC+1)

**Mo-Thu 7.00 a.m. - 4.00 p.m., Fr 7.00 a.m. - 1.00 p.m.

1.3 Training courses

Bender is happy to provide training regarding the use of test equipment. The dates of training courses and workshops can be found on the Internet at www.bender.de > Know-how > Seminars.

1.4 Delivery conditions

Bender sale and delivery conditions apply.

For software products the "Softwareklausel zur Überlassung von Standard-Software als Teil von Lieferungen, Ergänzung und Änderung der Allgemeinen Lieferbedingungen für Erzeugnisse und Leistungen der Elektroindustrie" (software clause in respect of the licensing of standard software as part of deliveries, modifications and changes to general delivery conditions for products and services in the electrical industry) set out by the ZVEI (Zentralverband Elektrotechnik- und Elektronikindustrie e. V.) (German Electrical and Electronic Manufacturer's Association) also applies.

Sale and delivery conditions can be obtained from Bender in printed or electronic format.

1.5 Inspection, transport and storage

Inspect the dispatch and equipment packaging for damage, and compare the contents of the package with the delivery documents. In the event of damage in transit, please contact Bender immediately.

The devices must only be stored in areas where they are protected from dust, damp, and spray and dripping water, and in which the specified storage temperatures can be ensured.

1.6 Warranty and liability

Warranty and liability claims in the event of injury to persons or damage to property are excluded if they can be attributed to one or more of the following causes:

- Improper use of the device.
- Incorrect mounting, commissioning, operation and maintenance of the device.
- Failure to observe the instructions in this operating manual regarding transport, commissioning, operation and maintenance of the device.
- Unauthorised changes to the device made by parties other than the manufacturer.
- Non-observance of technical data.
- Repairs carried out incorrectly and the use of replacement parts or accessories not approved by the manufacturer.
- Catastrophes caused by external influences and force majeure.
- Mounting and installation with device combinations not recommended by the manufacturer.

This operating manual, especially the safety instructions, must be observed by all personnel working on the device. Furthermore, the rules and regulations that apply for accident prevention at the place of use must be observed.

1.7 Disposal

Abide by the national regulations and laws governing the disposal of this device. Ask your supplier if you are not sure how to dispose of the old equipment.

The directive on waste electrical and electronic equipment (WEEE directive) and the directive on the restriction of certain hazardous substances in electrical and electronic equipment (RoHS directive) apply in the European Community. In Germany, these policies are implemented through the "Electrical and Electronic Equipment Act" (ElektroG). According to this, the following applies:

- Electrical and electronic equipment are not part of household waste.
- Batteries and accumulators are not part of household waste and must be disposed of in accordance with the regulations.
- Old electrical and electronic equipment from users other than private households which was introduced to the market after 13 August 2005 must be taken back by the manufacturer and disposed of properly.

For more information on the disposal of Bender devices, refer to our homepage at www.bender.de > Service & support.

2. Safety instructions

2.1 General safety instructions

Part of the device documentation in addition to this manual is the enclosed "Safety instructions for Bender products".

2.2 Work activities on electrical installations



Only **qualified personnel** are permitted to carry out the work necessary to install, commission and run a device or system.



DANGER

Risk of electrocution due to electric shock!

Touching live parts of the system carries the risk of:

- An electric shock
- Damage to the electrical installation
- Destruction of the device

Before installing and connecting the device, make sure that the *installation* has been *de-energised*. Observe the rules for working on electrical installations.

If the device is used outside the Federal Republic of Germany, the applicable local standards and regulations must be complied with. The European standard EN 50110 can be used as a guide.

2.3 Intended use

The loop monitor of the GM420 series is designed to monitor the PE conductor in AC systems. The extraneous voltage U_f between the terminals E and KE must not exceed AC 12 V. The ohmic resistance of the conductor loop and the existing extraneous AC voltage U_f will be indicated on the display.

Measurement results can be adversely affected by DC extraneous voltage U_f occurring during the resistance measurement process.

Separate supply voltage U_s is required.

In order to meet the requirements of the applicable standards, customised parameter settings must be made on the equipment in order to adapt it to local equipment and operating conditions.

Please heed the limits of the range of application indicated in the technical data.

Any use other than that is regarded as improper.

3. Function

3.1 Device features

- Loop monitoring of the PE conductor in AC systems
- Loop resistance measurement and indication in the range of 0...100 Ω . The extraneous voltage U_f must not exceed A 12 V.
- Measurement and indication of an existing extraneous voltage U_f of AC 0...50V, even when the resistance measuring circuit has been disconnected to provide protection.
- Measuring current $I_m = \text{DC } 20 \text{ mA}$
- Preset function:
Automatic setting of the response value for the loop resistance $R_m (> R)$
- r.m.s. value measurement of the extraneous AC voltage $U_f (> U)$
- Start-up delay, response delay and delay on release
- Adjustable switching hysteresis for R and U
- Measured value display via multi-functional LC display
- Alarm indication via LEDs (AL1, AL2) and changeover contacts (K1, K2)
- N/C or N/O operation selectable
- Password protection against unauthorized parameter changing
- Fault memory can be deactivated

3.2 Function

Once the supply voltage is applied, the start-up delay t is activated. Measured resistance and voltage values changing during this time do not influence the switching state of the alarm relays.

The devices provide two individually adjustable measuring channels (loop resistance/extraneous voltage U_f). When the measuring quantity exceeds the response value (Alarm 1) or falls below the response value (Alarm 2), the time of the response delays $t_{\text{on } 1/2}$ begins. When the response delay has elapsed, the alarm relays switch and the alarm LEDs light. When the measuring value exceeds or falls below the release value (response value plus hysteresis) after the alarm relays have switched, the selected release delay t_{off} begins. When

t_{off} has elapsed, the alarm relays switch back to their original state. With the fault memory activated, the alarm relays do not change their actual state until the reset button R is pressed.

3.2.1 Preset function

After connecting the device for the first time, the response value for the loop resistance (Alarm 1) is automatically set once only to the following value:

Response value loop resistance

$$(> R) = (R_m + 0.5\Omega) \times 1.5$$

GM420		
Extraneous voltage > U (U_f)	Preset operating range	Response value > R
AC 25 V	0...∞ Ω	$(R_m + 0.5\Omega) \times 1.5$ max. 100 Ω

If the measured resistance value is > 66 Ω, the response value will automatically be set to 100 Ω.

If loop resistances of approx. ≥ 1 kΩ exist, the preset function will be ineffective. Hence, the previous response value will remain. The message "AL not SET" appears on the display. If you exit "AL not SET" with Enter, the response value will be set to 100 Ω.

For details on how to change the response value manually refer to page 33. After restoring the factory settings, the preset function is automatically active again. Also refer to page 40.

During operation, the preset function can be started manually via the menu SEt. Also refer to page 41.

3.2.2 Protected measuring circuit

During the loop resistance measurement, the existing extraneous voltage must not exceed specified values. If the extraneous voltage exceeds the limit values, the measuring circuit will be disconnected (Overload OL). This protective mechanism will also be activated when the loop resistance values are too high.

A separate measuring circuit ensures that extraneous voltages $U_f (>U)$ of 1...50 V will be monitored!

The table below shows the respective switching thresholds and the corresponding messages shown on the display:

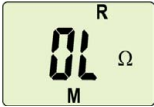
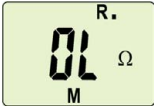
$U_f (> U)$ $R_m (> R)$	Display	Meaning
$\geq 12 \text{ V} /$ $\geq \text{ca. } 1 \text{ k}\Omega$		The measuring circuit has been deactivated by the device software.
$\geq 15 \text{ V} /$ $\geq \text{approx. } 5 \text{ k}\Omega$		The measuring circuit has been additionally deactivated by the device hardware. (additional R).

If the extraneous voltage U_f falls below values $\leq 10 \text{ V}$, the loop resistance measuring circuit will be activated again, provided that the measured loop resistance does not exceed the limit of approx. 1 k Ω .

3.2.3 Automatic self test

The device automatically carries out a self test after connecting to the system to be monitored and later every hour. During the self test internal functional faults are detected and will appear in form of an error code on the display. The alarm relays are not checked during this test.

By default, K1 signals the faults detected.

3.2.4 Manual self test

After pressing the internal test button for > 1.5 s, a self test is performed by the device. During this test, functional faults will be determined and appear in form of an error code on the display. The alarm relays are not checked during this test.

While the test button T is pressed and held down, all device-related display elements are indicated on the display.

3.2.5 Functional faults

If an internal functional fault occurs, all three LEDs flash. An error code will appear on the display (E01...E32).

For example, E08 means: Incorrect internal calibration. In such a case please contact the Bender Service.

3.2.6 Fault memory

The fault memory can be deactivated. A stored fault can be deleted by pressing the reset button "R".

3.2.7 Assigning alarms to the alarm relays K1/K2

Different alarm categories can be assigned to the alarm relays K1/K2 via the menu "out".

3.2.8 Time delays t , t_{on} and t_{off}

The times t , t_{on} and t_{off} , described below, delay the output of alarms via LEDs and relays.

Start-up delay t

After connection to the supply voltage, the alarm indication is delayed by the preset time t (0...99 s).

Response delay t_{on}

When the response value is reached, the loop monitor requires the response time t_{an} until the alarm is activated.

A preset response delay t_{on} (0...99 s) adds up to the device-related operating time t_{ae} and delays alarm signalling (total delay time $t_{an} = t_{ae} + t_{on}$).

If the fault does not continue to exist before the time of the response delay has elapsed, an alarm will not be signalled.

Delay on release t_{off}

When no alarm exists after deactivating the fault memory, the alarm LEDs go out and the alarm relays switch back to their original state. The release delay (0...99 s) allow to maintain the alarm state for the selected period.

3.2.9 Password protection (on, OFF)

After activating the password protection (on), settings are only possible when the correct password (0...999) has been entered. If you cannot operate your device because you cannot remember your password, please contact info@bender-service.de

3.2.10 Factory setting FAC

After activating the factory setting, all settings previously changed are reset to delivery status. In addition, the preset function allows automatic adaptation of the response value in relation to the loop resistance.

3.2.11 Erasable history memory

The first alarm value that occurs will be stored in this memory.

Subsequent alarms do not overwrite this "old" value. The memory can be cleared using the Clr key in the menu HiS.

4. Installation and connection

**DANGER**

*Ensure safe isolation from supply in the installation area.
Observe the installation rules for live working.*

General dimension diagram and drawing for screw fixing

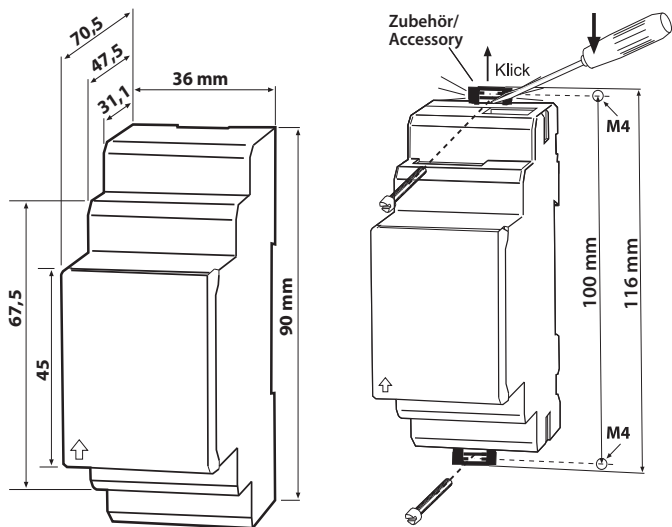

The front plate cover is easy to open at the lower part marked by an arrow.

1. DIN rail mounting:

Snap the rear mounting clip of the device into place in such a way that a safe and tight fit is ensured.

Screw fixing:

Use a tool to move the rear mounting clips (a second mounting clip is required, see ordering information) to a position that it projects beyond the enclosure. Then fix the device using two M4 screws.

2. Wiring

Connect the device according the wiring diagram.

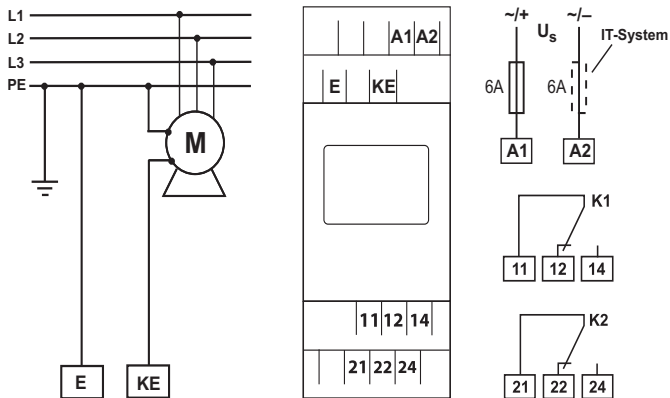

Terminal	Connections
A1, A2	Connection to supply voltage U_s
E	Connection to PE conductor (equivalent to functional earth)
KE	Connection to monitoring conductor E
11, 12, 14	Alarm relay K1
21, 22, 24	Alarm relay K2

5. Commissioning

Prior to commissioning, check that the GM420 is wired correctly and carry out the functional tests.

5.1 Preset function/ factory setting



During initial commissioning, a predefined response value is automatically set after applying the supply voltage depending on the measured loop resistance R_m (preset function).

$$\text{Response value loop resistance:} \\ (> R) = (R_m + 0.5 \Omega) \times 1.5$$



Hysteresis (R Hys)	25 %
Extraneous voltage (> U)	25 V
Hysteresis (U Hys)	5 %
Fault memory M	ON
Operating mode K1 (> R)	N/O operation (n.o.)
Operating mode K2 (> U)	N/O operation (n.o.)
Start-up delay	$t = 0 \text{ s}$
Response delay	$t_{on1} = 0 \text{ s}$
	$t_{on2} = 0 \text{ s}$
Delay on release	$t_{off} = 0.5 \text{ s}$
Password	0, Off

5.2 Functional tests

The system operator is obliged to have the loop monitor checked for proper functioning at regular intervals by a qualified electrician, see also IEC 60364-6 (6.5 Periodic verification).

Bender recommends a recurring inspection at least every 6 months, although national or normative regulations may regulate other inspection periods.

The following functional tests must be carried out as a minimum:

5.2.1 Alarm relays

Switching the alarm relays by a manual self-test (page 18). The function is to be checked or proven by means of measurement.





- *If necessary, a **parameter adjustment** in the **out menu for r1 and r2** is required in advance for this (page 31).*
- *The set mode of operation of the alarm relays must be taken into account, page 35.*

5.2.2 Conductor loop resistance

Check the conductor loop resistance by means of (manual) measurement and testing of the loop interruption detection:

1. Switch off the supply voltage.
2. Remove the connections E and KE.
3. Determine the resistance of the conductor loop by means of (manual) measurement. The measured loop resistance should approximately correspond to the reference value ($< 100 \Omega$).

4. Switch on the supply voltage.

Display	active LEDs	Precondition	Meaning
	ON, AL1	The conductor loop is open or disconnected, see step 2.	Device without error
	ON		Device error

5. Switch off the supply voltage.
6. Connect E and KE to the loop monitoring relay according to the wiring diagram, see page 22
7. Switch on the supply voltage.

5.3 Fast commissioning of the loop monitor in AC systems

If you are already familiar with the function of loop monitoring, you can reduce the time for commissioning and connection using this brief description.

1. Check that the PE conductor to be monitored is operated in an AC system. In addition, check that the resistance of the conductor loop is $\leq 66 \Omega$ and that the extraneous voltage is $U_f < 12 \text{ V}$. This is the precondition for an automatic setting of the response values (Preset) after the first connection to the supply voltage.

When the loop resistance is $> 66 \Omega$, a response value of 100Ω will automatically be set.

2. Make sure that the loop monitor is in the delivery status (factory setting has not been changed). In case of doubt, restore the factory setting (page 40).
3. When the conditions 1 and 2 are satisfied, you can connect the loop monitor according to the wiring diagram (page 22). Once the device is connected to the supply voltage, the device determines the loop resistance R_m and automatically sets the response value $> R$ for the loop resistance R_m :

$$\text{Response value } (> R) = (R_m + 0.5 \Omega) \times 1.5$$

Example:

$$R_m = 2.5 \Omega$$

$$\text{Resulting response value: } (2.5 \Omega + 0.5 \Omega) \times 1.5 = 4.5 \Omega$$

4. The currently measured loop resistance between the terminals E and KE appears on the display. In addition, you can query the existing extraneous voltage U_f using the UP and DOWN keys.

For detailed information about the preset function refer to page 16.



Page 43 provides a summary of all factory settings.

If you want to reset the loop monitor to its factory settings, refer to the description on page 40.

6. Operation and setting

6.1 Display elements in use

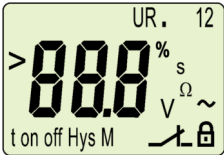
A detailed description of the meaning of the display elements is given in the table below.

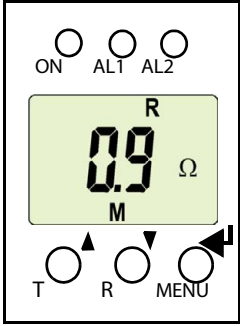

Display elements in use	Element	Function
	> R > U~	Loop resistance (Alarm 1) Extraneous voltage (Alarm 2)
	1, r1 R2, r2	Alarm relay K1 Alarm relay K2
	R, U Hys %	Response value hysteresis as %
	OL	Response value (that is non-adjustable) is exceeded (Overload)
	ton1 ton2 t toff	Response delay t_{on1} (K1) Response delay t_{on2} (K2) Start-up delay t Delay on release t_{off} K1, K2
	M	Fault memory active
		Operating mode of the relays K1, K2
		Password protection activated

6.2 Function of the operating elements

Device front	Element	Function
	ON	Power On LED, green
	AL1	LED Alarm 1 lights (yellow): Response value > R exceeded
	AL2	LED Alarm 2 lights (yellow): Res- ponse value > U reached
	0.9 Ω	Display in standard mode: $R_m = 0.9 \Omega$;
	M	Fault memory active
	t	Test button (> 1.5 s): To indicate the available display ele- ments, to start a self test;
	▲	Up key (< 1.5 s): Menu items/values
R	Reset button (> 1.5 s):	
▼	Deleting the fault memory; Down key (< 1.5 s): Menu items/values	
MENU	MENU key (> 1.5 s): Starting the menu mode; Enter key (< 1.5 s): Confirm menu item, submenu item and value. Enter key (> 1.5 s): Back to the next higher menu level	

6.3 Menu structure

All adjustable parameters are listed in the columns "menu item" and "adjustable parameters". A display-like representation is used to illustrate the parameters in the column menu item. Different alarm categories can be assigned to the alarm relays K1, K2 via the submenus r1, r2. This is done by activation or deactivation of the respective function.

Menu	Submenu	Menu item	Acti- vation	Adjustable parameter
AL (response values)	→	> R	-	Loop resist. in Ω (Alarm 1)
		R Hys	-	Hysteresis, > R
		> U	-	Extran. voltage (Alarm 2)
		U Hys	-	Hysteresis, extran. voltage
out (output control)	→	M	ON	Fault memory (on, off)
		 1	-	Operating mode K1 (n.o.)
		 2	-	Operating mode K2 (n.o.)
	r1 (K1: (assignment alarm category))	1 Err	ON	Device error at K1
		r1 > R	ON	Loop resistance at K1 too high
		1 OL	ON	Measuring current disconnection at K1
		r1 > U	off	Extran. voltage at K1
		1 tES	off	Manual device test at K1
		r2 (K2: (assignment alarm category))	2 Err	off
	r2 > R		off	Loop resistance at K2 too high
	2 OL		off	Measuring current disconnection at K2
	r2 > U		ON	Extraneous voltage K2
	2 tES		off	Manual device test at K2

t (timing check)	→	t on 1	Response delay K1
		t on 2	Response delay K2
		t	Start-up delay
		t off	Delay on release K1/K2
Set (device control)	→		Parameter setting via password
		FAC	Restore factory settings
		PrE	Manual preset
		SYS	Function blocked
InF	→		Display hard / software version
HiS	→	Clr	History memory for the first alarm value, erasable

6.4 Display in standard mode

By default, the resistance between the terminals E and KE is indicated on the display.

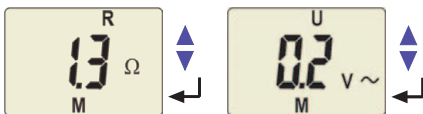

In the standard mode, the currently measured values of the loop resistance or extraneous voltage can be displayed by using the Up and Down keys.

In order to change the default display, confirm your choice with Enter.

6.5 Display in menu mode

6.5.1 Parameter query and setting: Overview

Menu item	Adjustable parameter
AL	Response values query and setting: <ul style="list-style-type: none"> – Loop resistance: > R (AL1) – Hysteresis of the response value: Hys > R – Extraneous voltage: > U (AL2) – Hysteresis of the response value: Hys > U
out	Configuration of the fault memory and the alarm relay: <ul style="list-style-type: none"> – Activating/deactivating the fault memory – Select N/O operation (n.o.) or N/C operation (n.c.) individually for each K1/K2 – Assign the alarm categories loop resistance, extraneous voltage or device error individually to each K1/ K2 (1, r1 / 2, r2).
t	Setting delays: <ul style="list-style-type: none"> – Response delay t_{on1}/t_{on2} – Start-up delay t – Delay on release t_{off} (LED, relay)
Set	Device control parameter setting: <ul style="list-style-type: none"> – Enable or disable password protection, change the password – Restore factory setting; – Starting preset function PrE; – Service menu SyS blocked
InF	Query hard and software version
HiS	Query the first stored alarm value
ESC	Move to the next higher menu level (back)

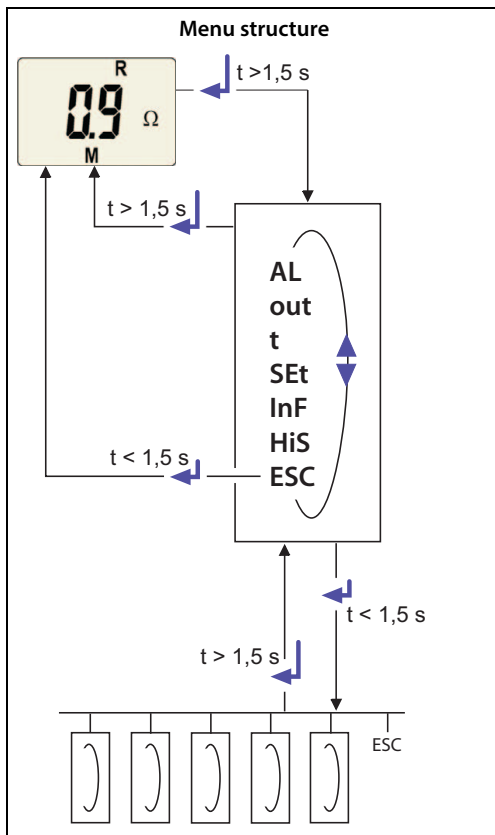

Parameter settings

An example is given below on how to change the alarm response value for the loop resistance $> R$. Proceed as follows:

1. Press the MENU/Enter key for more than 1.5 seconds. The flashing short symbol AL appears on the display.
2. Confirm with Enter. The symbols $> R$ flash.
3. Confirm with Enter. the current value for Ω flashes.
4. Use the Up or Down key to set the appropriate response value. Confirm with Enter. $> R$ flashes.
5. You can exit the menu by:
 - Pressing the Enter key for more than 1.5 seconds to reach the next higher level or
 - selecting the menu item ESC and confirming with Enter to reach the next higher level.



The currently active segments are flashing! In the figures below, the segments where device settings can be carried out are highlighted by an oval.

The menu mode can be reached by pressing the MENU key for more than 1.5 seconds.

6.5.2 Setting the response values for loop resistance and the associated hysteresis

Set the resistance value at which an alarm is to be signalled.

Setting the response value for the loop resistance

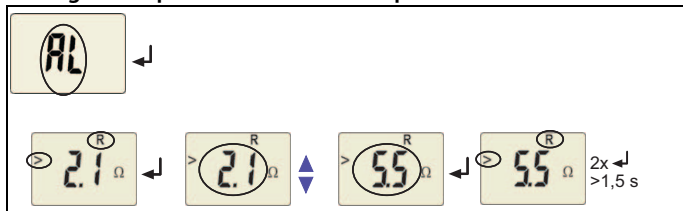

Setting the hysteresis of the resistance response value

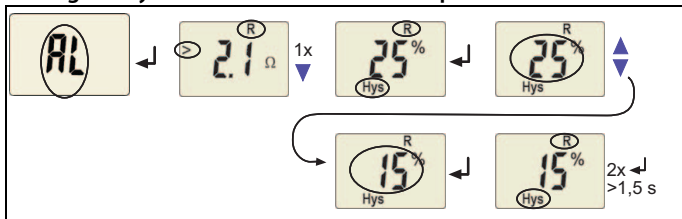

6.5.3 Setting the response values for extraneous voltage and hysteresis

Set the extraneous voltage response value at which an alarm is to be signalled.

Setting the extraneous voltage response value (> U)

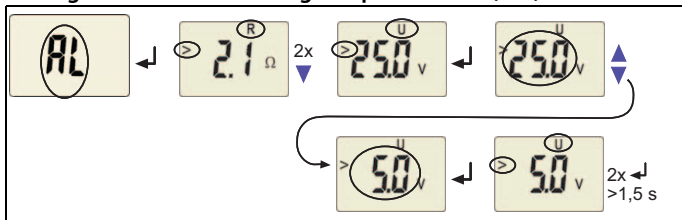

Setting the hysteresis for extraneous voltage

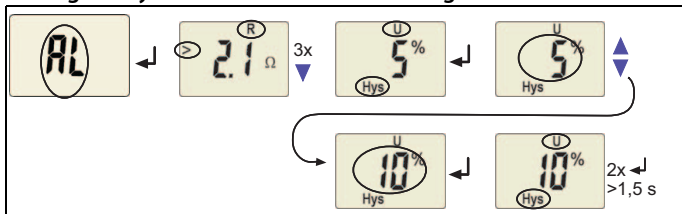

6.5.4 Setting the fault memory and operating mode of the alarm relays

Deactivating the fault memory

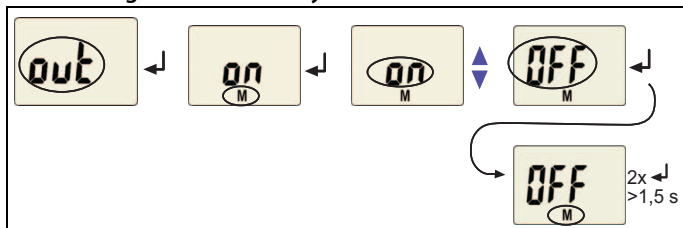

Setting the alarm relay K1 to N/C operation (n.c.)

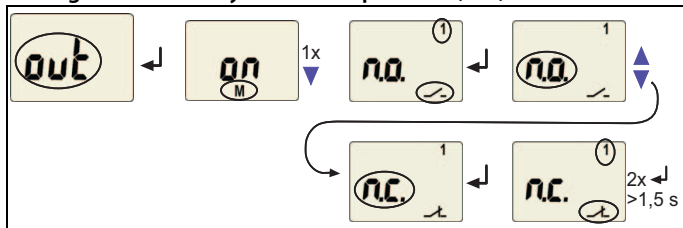

6.5.5 Assigning alarm categories to the alarm relays

Loop resistance, extraneous voltage and device-related errors can be assigned to the alarm relays K1 (r1, 1) and K2 (r2, 2). By default, K1 signals an alarm in case of too high loop resistance. K2 signals an alarm in case of too high extraneous voltage U_f .

A few assignment examples for alarm relay K1 are illustrated below:

Alarm relay K1: Deactivating the category device error

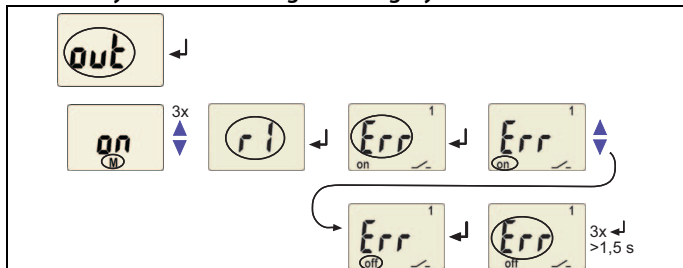

Alarm relay 1: Deactivating the category loop resistance

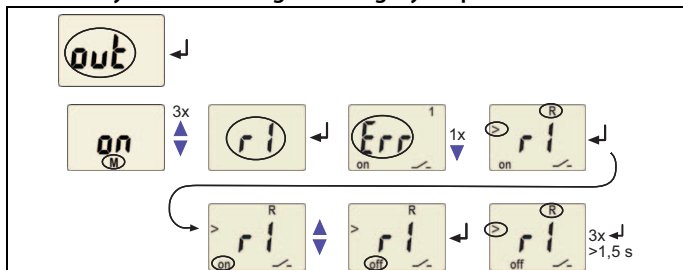

Alarm relay 1: Deactivating the category measuring current disconnection

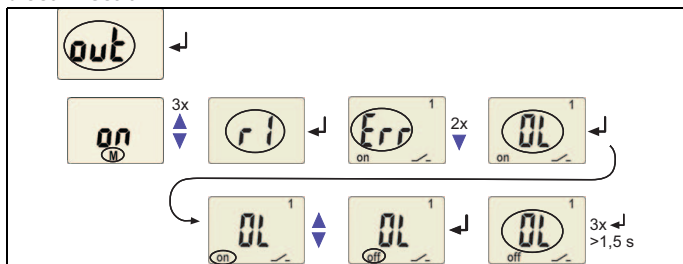

Alarm relay 1: Activating the category extraneous voltage

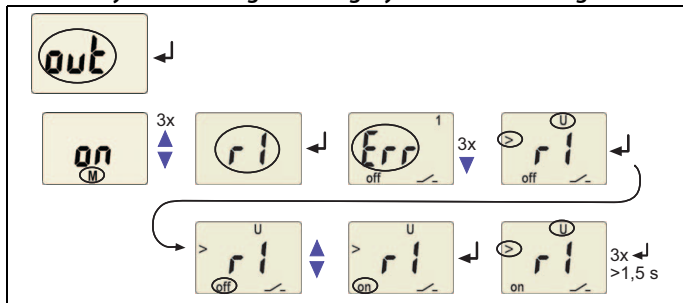

Alarm relay 1: Activating the category manual self test

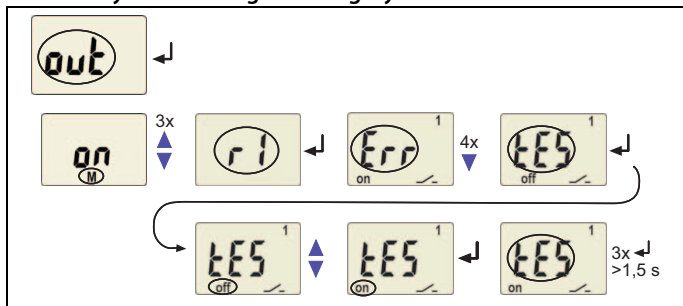

When an alarm relay (K1/K2) has been deactivated in the menu, an alarm will not be signalled by the respective changeover contact! An alarm will only be indicated by the respective alarm LED (AL1/AL2)!

6.5.6 Setting time delays

Use this segment to set a

- response delay t_{on1} (0...99 s) for K1
- response delay t_{on2} (0...99 s) for K2
- start-up delay t (0...99 s) when starting the device
- common release delay t_{off} (0...99 s) for K1, K2

This setting is only relevant when the fault memory M is deactivated.

The operating steps for the setting of the response delay t_{on1} and the start-up delay t are illustrated by way of example.

Setting the response delay t_{on1}

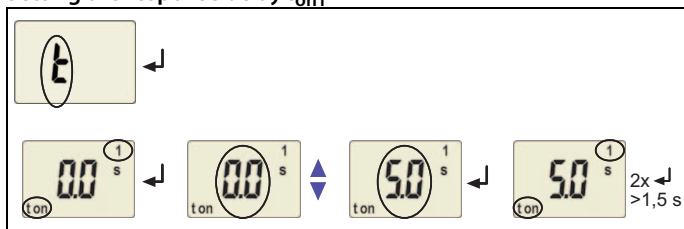

Setting the start-up delay t

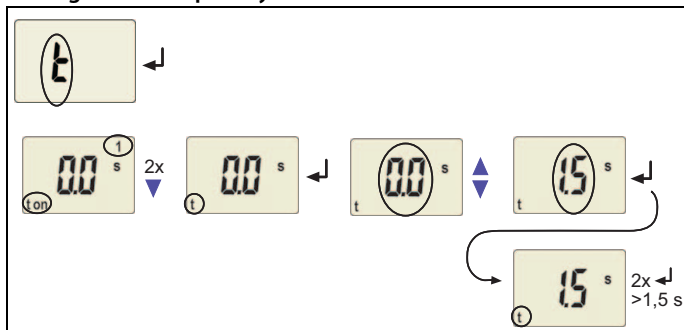

6.5.7 Factory setting and password protection

Use this menu to activate the password protection, to change the password or to deactivate the password protection. In addition, you can reset the device to its factory settings.

a) Activating the password protection

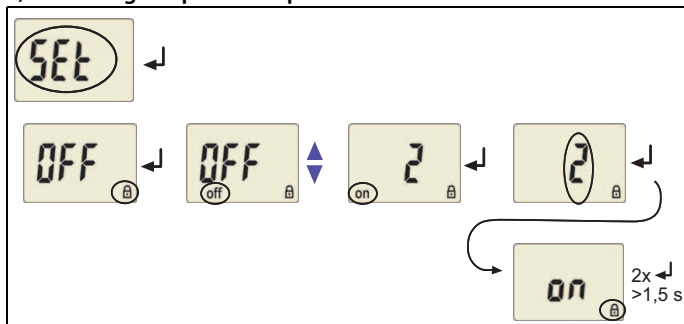

b) Changing the password

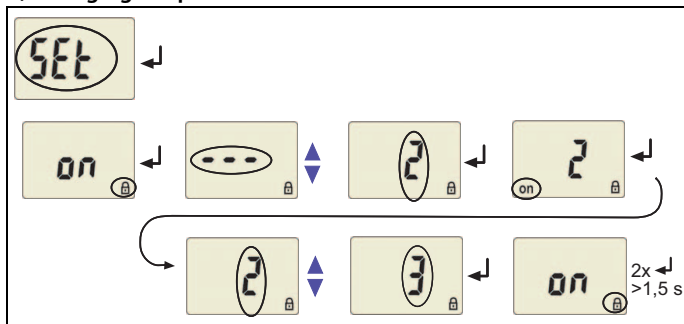

c) Deactivating the password protection

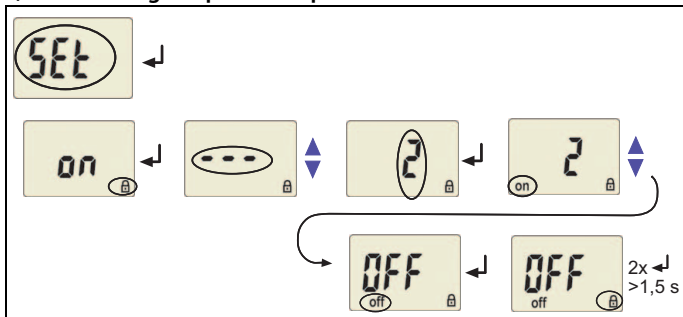

6.5.8 Restoring factory setting

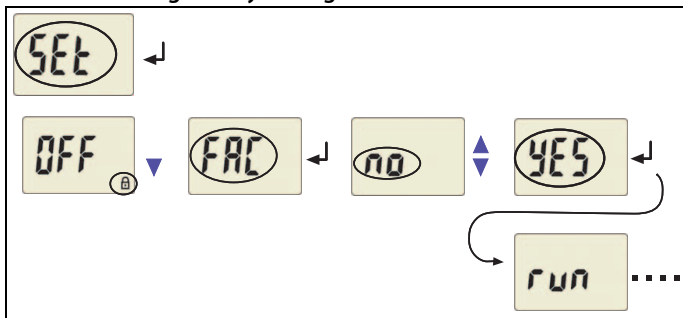

6.5.9 Manual activation of the preset function

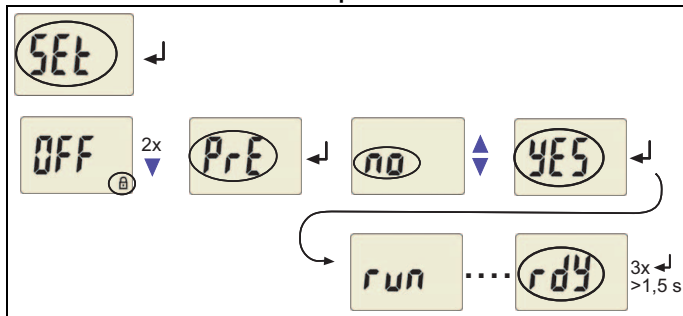

If loop resistances of approx. $\geq 1 \text{ k}\Omega$ exist, the preset function will be ineffective. The message "AL not SEt" appears on the display.

6.5.10 Device information query

This function is used to query the hardware (d...) and software (1.xx) versions. After activating this function, data will be displayed as a scrolling text. Once one pass is completed you can select individual data sections using the Up/Down keys.

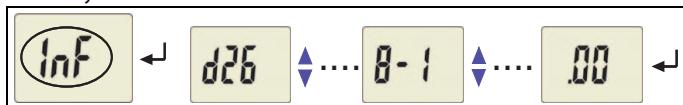

6.5.11 History memory query

The history memory can be selected via the menu HiS. Use the Up and Down keys to view the next display. If Clr is flashing, the history memory can be cleared by pressing the Enter key.



7. Technical data GM420...

7.1 Tabular data

()* = factory setting

Insulation coordination acc. to IEC 60664-1 / IEC 60664-3

Rated insulation voltage	400 V
Rated impulse voltage/pollution degree	4 kV / III
Protective separation (reinforced insulation) between	(A1, A2) - (E, KE) - (11-12-14) - (21-22-24)
Voltage test acc. to IEC 61010-1	
(E, KE) - [(A1-A2), (11-12-14)]	3.32 kV
(E, KE) - (21-22-24)	2.21 kV
(A1- A2) - (11-12-14) - (21-22-24)	2.21 kV

Supply voltage

GM420-D-1

Supply voltage U_s	AC 16...72 V / DC 9.6...94 V
Frequency range U_s	15...460 Hz

GM420-D-2

Supply voltage U_s	AC/DC 70...300 V
Frequency range U_s	15...460 Hz
Power consumption	≤ 3.5 VA

Measuring circuit

Loop resistance R_m

Measuring range R_m	0...100 Ω
Measuring current I_m	DC 20 mA
Measuring voltage U_m	≤ DC 24 V

Extraneous voltage U_f

Measuring range U_f	AC 0...50 V
Nominal frequency f_n	42...460 Hz
Disconnection of the measuring loop U_f	≥ 12 V
Reclosing of the measuring loop	≤ 10 V
Permissible extraneous voltage U_f	≤ 440 V
Permissible extraneous DC voltage, without influence on the measurement	DC 0 V

Response values

Loop resistance (> R) (Alarm 1)	0.1 ... 100 Ω
Resolution of setting R 0.1 ... 10 Ω	0.1 Ω
Resolution of setting R 10 ... 100 Ω	1 Ω
Preset function:	
Loop resistance (> R)	$= ((R_m + 0.5 \Omega) \times 1.5) *$
Relative percentage error 0 ... 1 Ω	$\pm 20 \%$, ± 1 digit
Relative percentage error 1 ... 10 Ω	$\pm 5 \%$, ± 1 digit
Relative percentage error 10 ... 100 Ω	$\pm 5 \%$, ± 1 digit
Hysteresis (> R)	1 ... 40 % (25 %)*
Extraneous voltage $U_f (> U)$ (Alarm 2)	1 ... 50 V (25 V)*
Resolution of setting U_f 1 ... 50 V	0.5 V
Relative percentage error $U_f (> U)$ in the range 50/60 Hz	$\pm 2 \%$, ± 1 digit
Relative percentage error $U_f (> U)$ in the range 42 ... 460 Hz	$\pm 10 \%$, ± 1 digit
Hysteresis > U	1 ... 40 % (5 %)*

Specified time

Start-up delay	0 ... 99 s (0 s)*
Response delay $t_{on1/2}$	0 ... 99 s (0 s)*
Release delay t_{off}	0 ... 99 s (0.5 s)*
Operating time t_{ae} when the loop is open ($R > 50 \text{ k}\Omega$)	≤ 40 ms
Operating time t_{ae} when the loop is closed (> R)	≤ 500 ms
Operating time t_{ae} if extraneous voltage $U_f (> U)$ and overload (OL) exist	≤ 100 ms
Response time t_{an}	$t_{an} = t_{ae} + t_{on1/2}$
Recovery time t_b	≤ 300 ms
Recovery time t_b after protective disconnection	≤ 1 s

Displays, memory

Display	LC display, multi-functional, not illuminated
Display range, measured value R_m	0 ... 100 Ω
Display range, measured value U_f	AC 0 ... 50 V
Operating error, loop resistance 0 ... 1 Ω	$\pm 20 \%$, ± 1 digit
Operating error, loop resistance 1 ... 100 Ω	$\pm 5 \%$, ± 1 digit
Operating error, voltage in the range 50/60 Hz	$\pm 2 \%$, ± 1 digit
Operating error, voltage in the range 42 ... 460 Hz	$\pm 10 \%$, ± 1 digit
History memory (HiS) for the first alarm value	data record measured values

Password off / 0 ... 999 (off)*
 Fault memory (M) alarm relay on / off (on)*

Switching elements

Number of changeover contacts 2 x 1 (K1, K2)
 Operating principle N/C operation / N/O operation
 ... K1: Err, > R, OL, > U, tES (device error, loop resistance, measuring current disconnection: N/O operation n.o.)*
 K2: Err, > R, OL, > U, tES (overvoltage: N/O operation n.o.)*
 Electrical service life under rated operating conditions,
 number of cycles 10000
 Contact data acc. to IEC 60947-5-1
 Utilization category AC 13 AC 14 DC-12 DC-12 DC-12
 Rated operational voltage 230 V 230 V 24 V 110 V 220 V
 Rated operational current 5 A 3 A 1 A 0.2 A 0.1 A
 Minimum contact load
 relay manufacturer's reference 10 mA/5 V DC

Environment / EMC

EMC EN 61326-1
 Ambient temperatures
 Operating temperature -25 ... +55 °C
 Transport -25 ... +70 °C
 Long-term storage -25 ... +55 °C
 Classification of climatic conditions acc. to IEC 60721
 Stationary use (IEC 60721-3-3) 3K22
 Transport (IEC 60721-3-2) 2K11
 Long-term storage (IEC 60721-3-1) 1K22
 Classification of mechanical conditions acc. to IEC 60721
 Stationary use (IEC 60721-3-3) 3M11
 Transport (IEC 60721-3-2) 2M4
 Long-term storage (IEC 60721-3-1) 1M12

Connection

Connection **screw terminals**

Connection properties

rigid/ flexible/ conductor sizes 0.2...4/0.2...2.5 mm²/ AWG 24...12

Multi-conductor connection (2 conductors with the same cross section):

rigid/ flexible 0.2...1.5 mm²/0.2...1.5 mm²

Stripping length 8...9 mm

Tightening torque..... 0.5...0.6 Nm

Connection type..... **push-wire terminals**

Connection properties

Rigid 0.2...2.5 mm² (AWG 24...14)

Flexible without ferrules.....0.75...2.5 mm² (AWG 19...14)

Flexible with ferrules 0.2...1.5 mm² (AWG 24...16)

Stripping length..... 10 mm

Opening force 50 N

Test opening, diameter2.1 mm

Other

Operating mode continuous operation

Mountingany position

Degree of protection, internal components (IEC 60529)..... IP30

Degree of protection, terminals (IEC 60529) IP20

Enclosure material polycarbonate

Flammability class UL94 V-0

DIN rail mounting acc. to IEC 60715

Screw fixing 2 x M4 with mounting clip

Software version D268 V1.0x

Weight ≤ 150 g

()* = Factory setting

7.2 Standards, approvals and certifications



7.3 Ordering information

Device type	Measuring range Loop resistance	Measuring range extraneous voltage U_f	Supply voltage U_s	Art. No.
GM420-D-1	0...100 Ω	AC 0...50 V	DC 9.6 V...94 V / AC 15...460 Hz, 16...72 V	B93082001
GM420-D-2	0...100 Ω	AC 0...50 V	DC 70...300 V / AC 15...460 Hz, 70...300 V	B93082002
Mounting clip for screw fixing (1 piece per device, accessories)				B98060008

7.4 Document revision history

Date	Document version	State/Changes
11.2022	02	<i>Corrected</i> Numbering chapter 2. <i>Editorial revision</i> chapter 7.1: Classification of climatic/mechanical conditions, min. contact load <i>Added</i> chapter 7.2: logo UKCA, LR chapter 7.4
10.2023	03	<i>Added</i> Chapter 5. Commissioning

INDEX

A

- Adjustable parameters, list 29
- Automatic self test 18

C

- currently measured values
 - Extraneous voltage 30
 - Loop resistance 30

D

- Delay on release toff 19
- Deleting the fault alarms 28
- Device features 15
- Display elements in use 27
- Display in menu mode 31
- Display in standard mode 30

E

- ENTER key 28
- Example of parameter setting 33

F

- factory 23
- factory setting 19, 23
- Fast commissioning 13
- Fault memory 18
- Function 15
- Functional faults 18

H

- How to use this manual 7

I

- Installation and connection 21

K

- K1: assignment alarm category 29
- K2: assignment alarm category 29

L

- LED Alarm 1 lights 28
- LED Alarm 2 lights 28

M

- Manual self test 18
- Menu
 - AL (response values) 29
 - HiS (history memory for the first alarm value) 30
 - InF (hard and software version) 30
 - out (output control) 29
 - Set (device control) 30
 - t (timing check) 30
- Menu structure 29
- Mounting clip for screw fixing 47

O

- Operating elements, function 28

Operation and setting 27

Ordering information 47

P

Parameter query and setting

- 31

Parameter setting

- Activating or deactivating the password protection 39
- Assigning alarm categories to the alarm relays 35
- Deactivating the fault memory 35
- Manual activation of the preset function 41
- Setting response values 33
- Setting the operating principle of the alarm relays 35
- Setting time delays 38

Password protection 19

Preset function 16

Protected measuring circuit 17

R

Reset button 28

Response delay ton 19, 38

S

Service 8

Setting response values

- Extraneous voltage ($> U$) 34
- Hysteresis extraneous voltage 34
- Loop resistance $> R$ 33
- Loop resistance hysteresis 34

Starting delay t 38

Starting the menu mode 28

Start-up delay t 19

Support 8

T

Technical data 43

Test button 28

Time delays 15, 18

Training courses 10

W

Wiring diagram 22

Work activities on electrical installations 13
workshops 10



Bender GmbH & Co. KG

PO Box 1161 • 35301 Grünberg • Germany
Londorfer Str. 65 • 35305 Grünberg • Germany
Tel.: +49 6401 807-0 • Fax: +49 6401 807-259
E-Mail: info@bender.de • www.bender.de

Photos: Bender archives



BENDER Group